



Health is the primary duty of life.

*Oscar Wilde*

Dear Friends of ErgoStrap®,

Nothing is more important to the human being than health. Health is essential for all of us.

Backaches are a major health problem these days. Almost 50% of all employees suffer from pain in the back and neck area.

To work in a bent down position means strain, especially for strapping pallets manually. If you are interested in strapping pallets ergonomically, you came to the right place.

That's what we do! Ergonomic, easy, efficient – ErgoStrap®!

Maybe you have never really paid attention to the “pallet strapping” issue.

Or have you yourself made the painful experience that strapping is more stressful than it actually seems?

Our suggestion:

Give your employees a break and increase the efficiency of your organization with the help of our ErgoStrap® systems! Browse, read – and give us a call if you have any questions.

I hope our technology provides health and efficiency solutions to you.

A handwritten signature in black ink, appearing to read "A. Kimmerle".

**Andreas Kimmerle**

Founder

of ErgoPack Deutschland GmbH



## The Problem

**Did you know?**

Strapping **50 pallets per day** with  
**2 straps each** means **each year** the operator

**at least**  
**bends down 50,000 times**  
**and**  
**walks around pallets**  
**25,000 times**



## Bending badly leads to back problems!

Manual pallet strapping causes back problems; requires more staff and leads to additional costs due to sick leave.

You can avoid it!

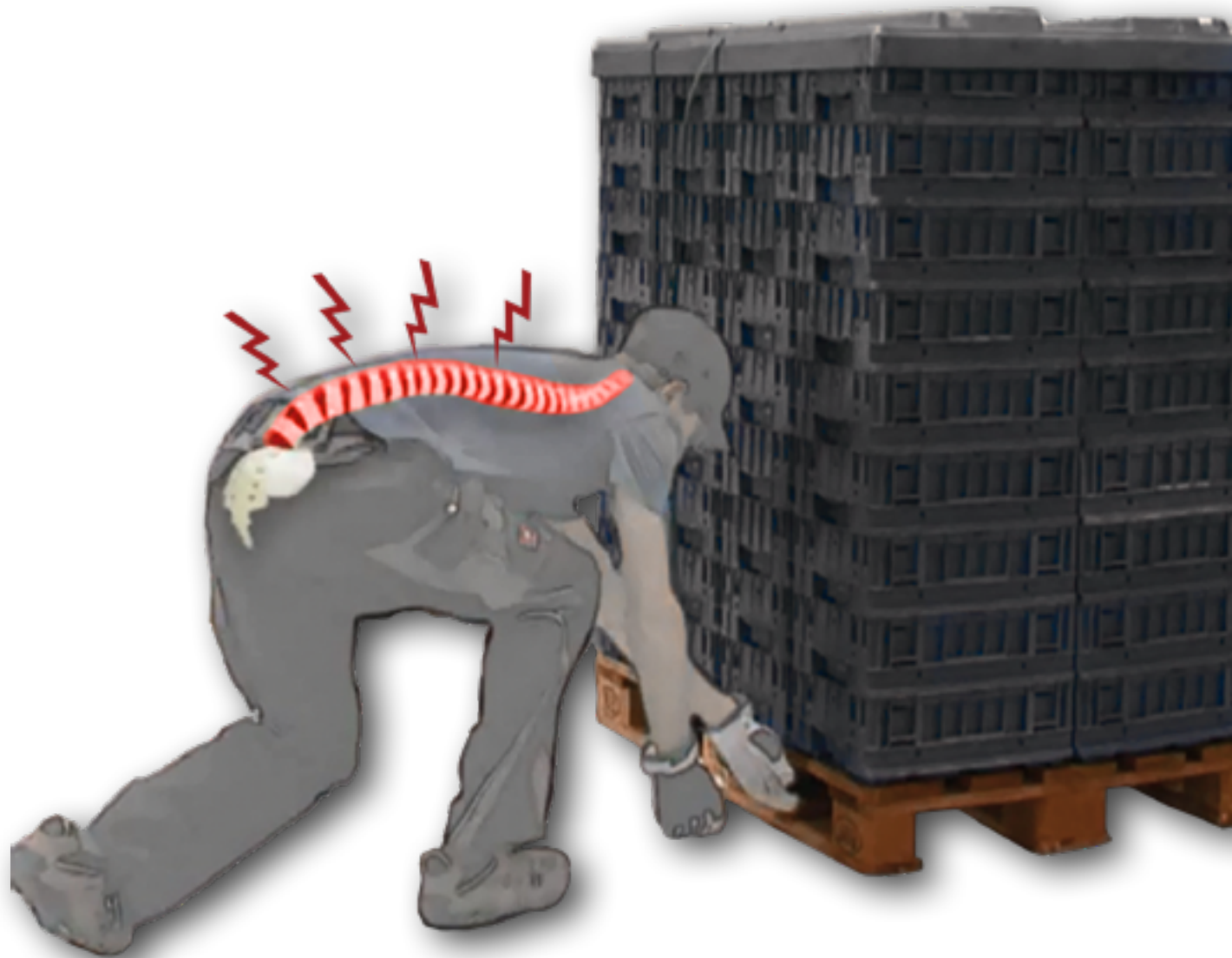

**Back pain is the most frequent cause of absenteeism.  
Main causes are a bent working position and poor bending practices.**



**HALF of all working Americans admit to having back pain symptoms each year**



**The total costs of back pain in the U.S. exceed \$50 billion per year**

Source: Vallfors B. Acute, Subacute and Chronic Low Back Pain: Clinical Symptoms, Absenteeism and Working Environment. Scan J Rehab Med Suppl 1985; 11: 1-98.  
In Project Briefs: Back Pain Patient Outcomes Assessment Team (BOAT). In MEDTEP Update, Vol. 1 Issue 1, Agency for Health Care Policy and Research, Rockville, MD.

## Improve processes by avoiding strain on the body. Create more efficient employees by providing a culture of safety.

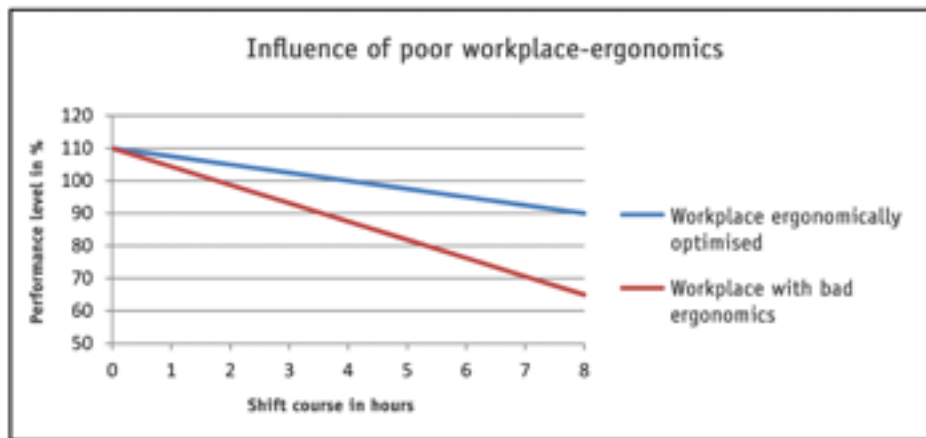

Source: Firm Quelle, based on workplace studies in shipping department

Keeping an employee healthy through retirement age will become a substantial factor for any enterprise in the course of demographic development.

It has to be the goal of each organization that employees can and want to be more productive.

To guarantee employment throughout a whole working life, we have to start rethinking how we work. Ergonomic workplaces and changes in processes are becoming more and more important in helping a workforce of all ages.

It is proven that ergonomically-optimized workplaces lead to higher productivity. Think ahead to increase your competitiveness and workforce engagement.



**But most of all: Show your employees that you care about their health.**

## The Solution

**With ErgoStrap:**  
Strapping 50 pallets per day with  
2 straps each means each year the operator  
exactly  
bends down  
0 times  
and  
walks around pallets  
0 times !





## ErgoStrap® – ergonomic, easy, efficient



1

Roll the ErgoStrap® system in front of the pallet. The ChainLance pulls the strap through under the pallet and up again on the rear side and over the pallet...



2

...right into the hand of the operator. Then the ChainLance retracts. The strap lifter hands the other end of the strap to the operator at working height...



3

...and the strap is tensioned and welded securely by the onboard integrated sealing head.

# The ErgoStrap® added value

Ergonomic, easy, efficient – that's ErgoStrap®.

## Ergonomic

ErgoStrap® is ergonomic: no bending down, no walking around the pallet.

This means: ErgoStrap® minimizes the risk of injuries and prevents back problems.

When strapping pallets manually, the operator has to bend down twice and walk around the pallet once. For a properly strapped pallet with two strappings, this means bending down four times and walking around twice.

50 pallets daily, with 2 strappings each, during 250 working days per year results in:

Bending down 50,000 times and 25,000 walks around pallets. ErgoStrap® puts an end to this!

## Easy

ErgoStrap® is easy to learn and comfortable to use. Your advantage: Short training period for your employees, a little appreciated job suddenly becomes

interesting and enjoyable.

Plus: With a higher safety level for the users, there have been no accidents reported to us after more than 10,000 systems delivered globally.

## Efficient

Reduced risk for back problems! Fun and motivation! More safety during the strapping process! A higher profitability and efficiency!

Which means for you:  
More efficient working processes lead to more productivity and safer workplaces.

Positive side-effect of the efficiency: More time!

We calculate:  
Even professionals take two minutes to strap a euro-pallet by hand twice.

With the ErgoStrap® anyone can do it in less than 40 seconds.

**Gaining time is an extra benefit free of charge!**

But see for yourselves:

Pallets per day	Time-saving per day	Time-saving per month
10	14 minutes	4,9 hours
30	42 minutes	14,7 hours
50	70 minutes	24,5 hours
100	140 minutes	49 hours

## What our customers say...



“Our shipping staff must regularly put heavy and unhandy packages on pallets and secure them for their travel to our customers. The ErgoStrap® 726X is already the second machine from ErgoStrap® that helps us with this task. The strapping system makes our job much easier: It significantly reduces the physical strain on our employees’ health and saves up to 40 minutes a day on 20 pre-stacked pallets. Our employees have their head clear for value-adding processes to ensure our quality standards in shipping to our customers. Compared to the former model, the 726X is easier to move. Thanks to its line laser, the machine can easily be placed at the correct distance in front of the pallet. The chain runs faster and is also quieter. The touchscreen with simple and intuitive operating logic is a great upgrade too. The ErgoStrap® 726X is an excellent system and ErgoStrap®’s support is absolutely customer-friendly, reliable and uncomplicated. ”

SMC Deutschland GmbH



“We will do anything we can to make it easier for our shipping guys! Let’s face it, none of us are getting any younger. This system eliminates our safety concern for bending while strapping and carrying the weight of the tool.”

Flexco

# AGR Seal of Approval

What characteristics does a product have to fulfil to provide the spinal column and the locomotor system with optimum support, providing relief and not acting as a burden for the user?

As this is not immediately apparent in most products and as industry and the retail sector do not have a clear view, the "Aktion Gesunder Rücken (AGR) e.V." has developed a decision-making aid for consumers:

The AGR Seal of Approval.

## Independently verified

The AGR Seal of Approval is awarded only to products whose back-friendly design has been verified by an independent testing committee made up of experts from various medical disciplines.

The special, and unique feature of the seal, is the medical multidisciplinary approach to deciding which products receive the AGR Seal of Approval, without being influenced by industry.

## Purchase decision

Products with a back-friendly design are essential and important aids in both preventing backache and in treating diseases of the locomotor system.

But it is not always easy to decide which product is the right one.

The Seal of Approval developed by the AGR, together with Germany's two largest back school associations therefore provides valuable assistance for consumers when purchasing ergonomic everyday products such as office furniture, car seats, beds, bikes, upholstered furniture, shoes, backpacks, furniture for children and home workstations etc.





[www.agr-ev.de](http://www.agr-ev.de)

### Multiple awards

The AGR Seal of Approval even received the accolade “very good” from the “ÖKOTEST” consumer magazine.

The evaluation forum “Label Online”, promoted by the German Department of Justice and Consumer Protection awarded the AGR Seal of Approval as “highly recommended”.

The strict testing criteria and the composition of the committee with designated medical experts means that the AGR Seal of Approval is well accepted in the medical world. For consumers the seal has become established as a clear decision making aid, confirming:

**ErgoStrap® is a back-friendly product.**



First prototype of a strapping device based on a double scissors system similar to a scissors lifting table.

**1998**



First serial model ErgoStrap® 300 for composite straps with a core diameter of 75mm, operated by a crank.

**2000**



The new ErgoStrap® 600 wins the gold medal at the International Exhibition of Inventors in Geneva, as well as the German Inventor's Award. With the help of the newly developed strap lifter, the operator does not have to bend down anymore at all.

**2002**



**1999**

Invention and patenting of the world's first ChainLance.

**2001**

Introduction of the ErgoStrap® 500 with a 5m long ChainLance to strap larger pallets with PP and PET strap with a 406mm core diameter.



**2003**

Change from the hand crank to an electronic motor operated by battery. The ErgoStrap® T makes side strapping of high pallets even possible. As different sealing heads can be attached to the device, the operator does not have to be bent over the hand.



# are sold in 55 countries – The Global Market Leader



ErgoStrap® 720E and 730E, the first complete strapping systems with an integrated sealing head and a centralised battery power supply, are part of our product range.

2008



2011

ErgoStrap® 725E and 740E. Integration of a totally new state-of-the-art sealing head.



The completely revised Model 2017 with over 40 new features is introduced.

2016

X-pert Line



2019

Economy Line



since 2018

ErgoStrap® Air



since 2014

The X-pert Line sets the new benchmark. Advanced electronics and newly designed touchscreens on the sealing head and the strapping system guarantee the user interface being intuitive. Also in terms of ergonomics, the X-pert Line sets a new standard.

The further development of the Model 2017. The new intuitive sealing head with touchscreen with an improved ergonomic fit and intuitive control. Reliable and safe strapping, for almost 20 years.

The ErgoStrap® Air becomes a milestone in pallet strapping. The worldwide one and only mobile system to strap raised pallets.



**X**

**X**

**X**

**X-treme ergonomic**

**X-treme comfortable**

**X-treme process reliable**



## Standard equipment

- ① Elegant operation via touchscreen and joystick with intuitive user guidance
- ② Fully integrated sealing head with touchscreen and ergonomically shaped controls
- ③ Tool-Lift counterbalances the operation of sealing head
- ④ Easy going and comfortable handling with ergonomically shaped handles
- ⑤ Fully covered for increased working safety in classy design





**Maximum pallet sizes:**

Width up to 94" / Height up to 90"

**Suitable types of strap:**

PP and PET straps

**Strap width:**

713X: 3/8" - 1/2"

726X: 1/2" - 5/8"

745X: 5/8" - 3/4"

**Tensioning force sealing head:**

713X: 150 N - 1.200 N

726X: 400 N - 2.500 N

745X: 400 N - 4.500 N

**Length of the ChainLance:**

20' / extendable to 23'

**Dimensions:**

Width 30" / Height 47" / Depth 26"

**Weight:**

254 lbs (incl. battery)

**Battery:**

36V AGM battery

## Model 700X

as models 713X / 726X / 745X,  
but without sealing head and without Tool-Lift





## Models 713E – 726E – 745E

The further development of the 2017 model. Reliable and safe strapping for almost 20 years. Proven technology in the field of ergonomic pallet strapping systems.

Compared to the new X-pert Line the E-conomy Line has fewer options. The strapping speed is lower and can not be adapted to the experience of the user. In addition, the E-conomy Line does not have a touch-screen. The pallet width is adjusted mechanically.

## Standard equipment

- ① Easy control via joystick without touchscreen
- ② Fully integrated sealing head with touchscreen and ergonomically shaped controls
- ③ Tool-Lift counterbalances the operation of sealing head
- ④ Easy going and comfortable handling with ergonomically shaped handles
- ⑤ Covered for high working safety

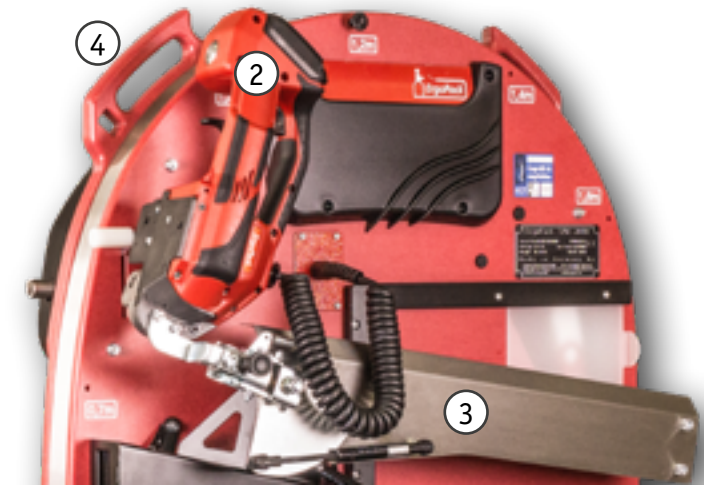



## Technical specifications

**Maximum pallet sizes:**

Width up to 94" / Height up to 90"

**Suitable types of strap:**

PP and PET straps

**Strap width:**

713E: 3/8" - 1/2"

726E: 1/2" - 5/8"

745E: 5/8" - 3/4"

**Tensioning force sealing head:**

713E: 150 N - 1.200 N

726E: 400 N - 2.500 N

745E: 400 N - 4.500 N

**Length of the ChainLance:**

20' / extendable to 23'

**Dimensions:**

Width 30" / Height 47" / Length 25"

**Weight:**

200 lbs (incl. battery)

**Battery:**

24V AGM battery

## Modell 700E



as models 713E / 726E / 745E  
but without sealing head and without Tool-Lift

## Modell 700



with manually driven ChainLance via crank

# Special equipment for X-pert Line and E-economy Line

## 1. Headpiece with bumper

For strapping pallets with lateral overlappings up to 1.6", e.g. cardboard covers or uneven side surfaces.

## 2. Line Laser

The Line Laser indicates the distance and the alignment of the machine to the pallet, which simplifies the positioning of the machine in front of the pallet.

## 3. Reversing sledge

Reversing sledge 85S (only available for E-economy Line):

Slimmer version of the standard sledge. Minimum clearance width: 6.3", instead of 7.3" in standard equipment.

Reversing sledge 47: (available for X-pert Line and E-economy Line)

Narrower version of the standard sledge. Minimum clearance height: 1.85", instead of 3.4" in standard equipment.

Reversing sledge 47S: (available for X-pert Line and E-economy Line)

Slimmer version of the reversing sledge 47. Minimum clearance width: 6.3", instead of 7.3" in standard equipment.

## 4. Triplex-Tool-Lift

The Triplex-Tool-Lift enables tensioning and sealing not only on the side of a pallet (side sealing), but also on the top (top sealing) without removing the sealing head from the Triplex-Tool-Lift. Minimum pallet height for side sealing is 30". Maximum pallet height for top sealing is 31". Minimum pallet height for top sealing is 4".

## 5. Sealing head removable from the Triplex-Tool-Lift

If the strap needs to be tensioned and sealed in positions which cannot be reached by the Triplex-Tool-Lift, e.g. inside a mesh transport box or for horizontal strapping. By pulling a bolt, the sealing head can be removed and the strap can be tensioned and welded in any position.







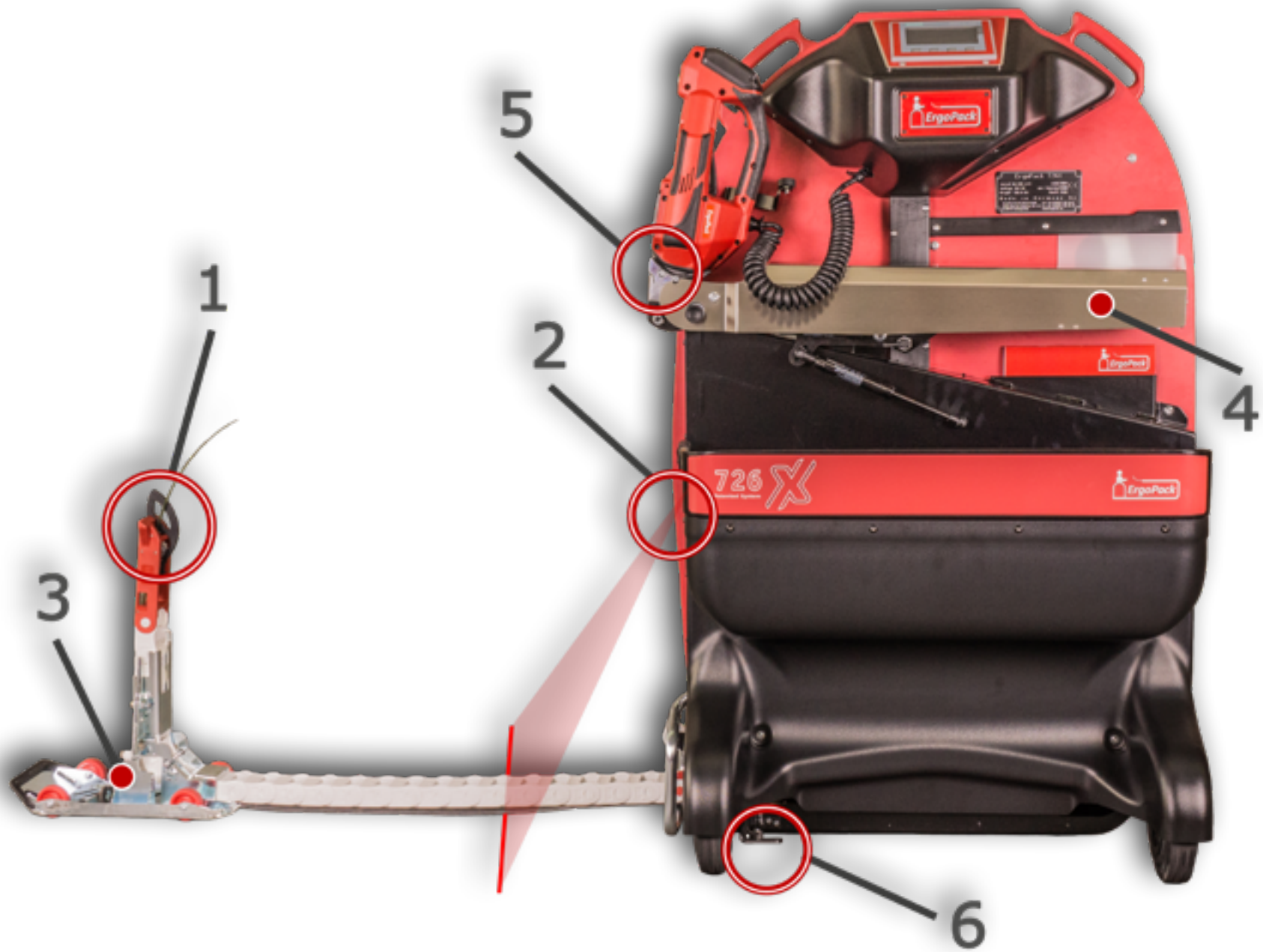



## 6. Strap brake relief

The brake resistance of the strap coil can be reduced to 20% by simply pushing a foot pedal. Manually pulling out strap is a lot easier, especially for pallets of 47" and higher.





## ErgoStrap® - Productrange

	 Line The Benchmark in Ergonomic Pallet Strapping				 Economy Line				
Model	700X	713X	726X	745X	700	700E	713E	726E	745E
									
Power	235W	235W	235W	235W	-	93W	93W	93W	93W
Drive	Electric motor with <b>reinforced angle gear</b> , electronically controlled				manually via a hand crank	Electric motor with <b>spur gear</b> , electronically controlled			
Battery Pack	3 x 12V AGM Battery	3 x 12V AGM Battery	3 x 12V AGM Battery	3 x 12V AGM Battery	-	2 x 12V AGM Battery	2 x 12V AGM Battery	2 x 12V AGM Battery	2 x 12V AGM Battery
Operating voltage	36V	36V	36V	36V	-	24V	24V	24V	24V
Strapping cycles per battery charge (standard strapping*)	650	650	650	650	-	350	350	350	350
Charger	36V Charger, 4,5A	36V Charger, 4,5A	36V Charger, 4,5A	36V Charger, 4,5A	-	2 x 12V Dual Charger, 2A	2 x 12V Dual Charger, 2A	2 x 12V Dual Charger, 2A	2 x 12V Dual Charger, 2A
Chain speed	2598"/min	2598"/min	2598"/min	2598"/min	-	1575"/min	1575"/min	1575"/min	1575"/min
Pallets width setting	via Siemens Industrial Touchscreen in 4" steps, works with work gloves				mechanically, by inserting a bolt in the appropriate position in 8" steps				
Other settings	individual setting options via the Siemens Industrial Touchscreen, such as: <ul style="list-style-type: none"> <li>• chain speed,</li> <li>• chain length,</li> <li>• standby timer,</li> <li>• strap lifter time for upper position,</li> <li>• Line Laser on/off,</li> <li>• Sealing head on/off</li> </ul>				-	-	-	-	-
Indicators	<ul style="list-style-type: none"> <li>• charging level indicated graphically and in %,</li> <li>• set pallet width,</li> <li>• permanent graphically indication of the ChainLance position,</li> <li>• strapping cycles,</li> <li>• sliding window open graphically and in writing,</li> <li>• safety instructions,</li> <li>• menu-driven step by step description for semi automated strap roll change</li> </ul>				-	3 LEDs indicating charging level and sliding window „open“			
Software update	easy update via USB stick				-	only by manufacturer			

standard equipment

	<b>X-part Line</b>	<b>The Benchmark in Ergonomic Pallet Strapping</b>		<b>economy Line</b>
--	--------------------	--	--	---------------------

	700X	713X	726X	745X	700	700E	713E	726E	745E
<b>standard equipment</b>	✓	✓	✓	✓	✓	✓	✓	✓	✓
<b>ChainLance</b>	special, glass fiber reinforced, high strength soft-slide chain								
<b>Tool-Lift</b>	-	✓	✓	✓	-	-	✓	✓	✓
<b>Sealing Head</b>	-	✓	✓	✓	-	-	✓	✓	✓
<b>Tension Force</b>	-	150N – 1200N	400N – 2500N	400N – 4500N	-	-	150N – 1200N	400N – 2500N	400N – 4500N
<b>Strap Types</b>	PP/PET	PP/PET	PP/PET	PP/PET	PP/PET	PP/PET	PP/PET	PP/PET	PP/PET
<b>Strap Width</b>	3/8" – 1"	3/8" – 1/2"	1/2" – 5/8"	5/8" – 3/4"	3/8" – 1"	3/8" – 1"	3/8" – 1/2"	1/2" – 5/8"	5/8" – 3/4"
<b>Strap Thickness</b>	0.019" – 0.051"	0.019" – 0.031"	0.019" – 0.040"	0.031" – 0.051"	0.019" – 0.051"	0.019" – 0.051"	0.019" – 0.031"	0.019" – 0.040"	0.031" – 0.051"

<b>special equipment</b>	-	✓	✓	✓	-	-	✓	✓	✓
<b>Triplex-Tool-Lift</b>	-	✓	✓	✓	-	-	✓	✓	✓
<b>Sealing Head removable</b>	-	✓	✓	✓	-	-	✓	✓	✓
<b>Line Laser</b>	✓	✓	✓	✓	-	✓	✓	✓	✓
<b>Strap Brake Relief</b>	✓	✓	✓	✓	✓	✓	✓	✓	✓
<b>Reversing Sledge</b>	47 / 47S	47 / 47S	47 / 47S	47 / 47S	47 / 47S / 85S	47 / 47S / 85S	47 / 47S / 85S	47 / 47S / 85S	47 / 47S / 85S
<b>Header with Bumper</b>	✓	✓	✓	✓	✓	✓	✓	✓	✓

<b>Accessories</b>	✓	✓	✓	✓	-	✓	✓	✓	✓
<b>Mobile Overheight Module</b>	✓	✓	✓	✓	-	✓	✓	✓	✓
<b>Stationary Sledge Tunnel</b>	✓	✓	✓	✓	-	✓	✓	✓	✓
<b>Mobile Sledge Tunnel Station</b>	✓	✓	✓	✓	-	✓	✓	✓	✓
<b>Ergonomic battery change trolley</b>	✓	✓	✓	✓	-	✓	✓	✓	✓

**\*Standard strapping:**  
 Battery pack: 100 charging- and discharging-cycles | Strap: 1/2" PET (complete strap roll) | Sealing Tool: 726, Tension Force 200 lbf without soft, Welding time 2nd range | Pallet: pallet width 32", pallet height 45" | Strapping speed: fast | Room temperature: 68 °F

# Accessories

Mobile Overheight Module – Enables strapping of pallets up to 120" height



This custom-made accessory is designed to strap pallets of up to 120" high.

It is an ideal solution to securely and gently strap pallets with protruding products or sensitive goods (such as surfaces).

Only the strap touches the goods.

Attaches to the ErgoStrap® machine via a detachable quick fastener.

When the Mobile Overheight Module is separated from the ErgoStrap® system, conventional pallets of up to 90" height can be strapped as usual.



Machine in use



Quick fastener - lateral



Quick fastener - detail

# Accessories

## Strapping for scantlings – Stationary Sledge Tunnels

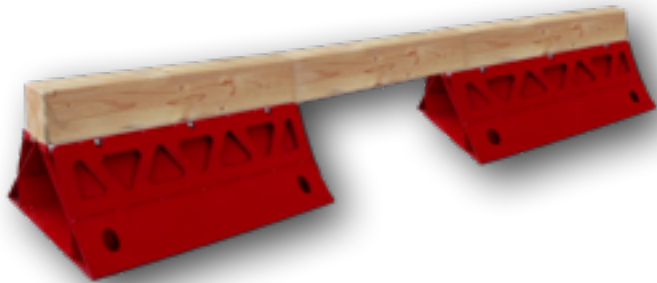

The Stationary Sledge Tunnels are fixed on the floor and can be used with every standard ErgoStrap® system. The Tunnels are individually adapted to the width of your scantlings.



# Accessories

## Strapping for scantlings – Mobile Sledge Tunnel Station



Flexible and precise. The Mobile Sledge Tunnel Station straps pallets including scantlings. The distance of the scantlings can be adjusted continuously by the aid of an integrated tape measure. Always adapted to your needs – the Mobile Sledge Tunnel Station is manufactured according to your requirements. The entire station can be moved to wherever you need to strap.



# Accessories

## Ergonomic battery change trolley



Ergonomic, easy and efficient – these features characterize our entire product range.

The ergonomic battery change trolley makes it easy to change the battery of the models of the ErgoStrap® X-pert Line and ErgoStrap® E-economy Line and ensures ergonomic and safe transport between the charging station and your ErgoStrap® strapping system. It can accommodate three battery packs.

4 caster wheels enable a comfortable positioning of the ergonomic battery change trolley to be latched to the ErgoStrap® system via connection bridge. Due to this stable connection, the battery can be changed easily. For the highest demands in every work environment.





# ErgoStrap® Air

ErgoStrap® Air 713-580 / 726-580 / 745-580 – Ergonomic pallet strapping system for raised pallets.



The ErgoStrap® Air is a revolutionary innovation in pallet strapping. The world wide one and only mobile system to strap raised pallets.

For use on conveyor lines, lift tables, carts and tigger trains.

For detailed information, please ask for our ErgoStrap® Air brochure or visit us at [www.ErgoStrapUSA.com](http://www.ErgoStrapUSA.com)



## Demo-Team

Are you interested in our ergonomic pallet strapping system but unsure if it will fit your application?

It will be our pleasure to visit you. We will demonstrate the system and all its capabilities in your environment. With your pallets. For your employees. At no charge of course and without any obligations. You will receive our custom tailored offer, perfectly adapted to your unique needs.

This is an essential advantage for you - particularly after purchase.

Quick and reliable: Our sales staff provide professional assistance on site – especially during commissioning and training - to ensure smooth working right from the start.



# Training

Our training helps your staff to get familiar with ErgoStrap® immediately.

## Training

It's as easy as this: Just book a training session for your employees right away with the purchase of the machine. Your ErgoStrap® specialist delivers your system and instructs your staff personally.

## Process

The training takes about two hours.

Everything will be shown, explained and trained:

- Basic functioning
- Changing the strap roll
- Operating elements of the control box
- Battery and charger
- Maintenance
- Special pallet application
- Safety advice

After the training you will receive a training protocol.



## Customer service



In case of accidents you need quick assistance. We can manage this.

Expert phone support is most common form of service, with service calls available and even machine refurbishing if eventually required.

Low maintenance, high reliability design and comprehensive documentation provide excellent uptime and low total cost of ownership.

Our System is completely modular, with a loaner program available, for repair of the sealing tool and operator control module.

Replacement Parts are well stocked in Milwaukee Wisconsin inventory.



# Manufacturer

Technological expertise in the field of pallet strapping has been the foundation of our company ever since its inauguration in 1999. In this context we develop, manufacture and distribute mobile pallet strapping systems of the highest quality which are unique worldwide.

Our goal is to significantly improve safety and ergonomics in the field of manual pallet strapping. Thereby we endeavour to improve the health and motivation of all users, as well as the efficiency of our customers' logistical processes.

At the same time we completely re-define the field of pallet strapping by focussing on innovative products with high functionality as well as unique patented selling points.



## ErgoPack Deutschland GmbH

Ergonomic pallet strapping systems  
Hanns-Martin-Schleyer-Strasse 21  
89415 Lauingen  
Germany

TEL: +49(0)9072 / 702 83-0  
FAX: +49(0)9072 / 702 83-29  
E-Mail: [info@ergopack.de](mailto:info@ergopack.de)  
Web: [www.ergopack.de](http://www.ergopack.de)



## Exclusive sales and service in the USA

### ErgoStrap Inc.

21925 Doral Rd.  
Waukesha, WI 53186  
USA

Phone: 414-316-9027  
E-Mail: [info@ErgoStrap.com](mailto:info@ErgoStrap.com)  
Web: [www.ErgoStrap.com](http://www.ErgoStrap.com)